

This product is intended for installation only by expert users. Please consult with a qualified technician for installation. Improper installation may result in damage to your equipment. EK Water Blocks assumes no liability whatsoever, expressed or implied, for the use of these products, nor their installation. The following instructions are subject to change without notice. Please visit our web site at [www.ekwb.com](http://www.ekwb.com) for updates. Before installation of this product please read important notice, disclosure and warranty conditions printed on the back of the block.

Before you start using this product please follow these basic guidelines:

1. Please carefully read the manual before through before beginning with the installation process!
2. Please remove your motherboard from the computer to assure safest mounting process in order to prevent any possible damages to your CPU and/or motherboard's circuit board (PCB).
3. The EK-HFB and EK-ACF type fittings require only a small amount of force to screw them firmly in place since the liquid seal is ensured by the rubber o-ring gaskets.
4. The use of quality, market proved corrosion inhibiting coolants is always strongly recommended for any liquid cooling system.

## STEP 1: GENERAL INFORMATION Sample photo of ASUS Maximus VIII Gene motherboard

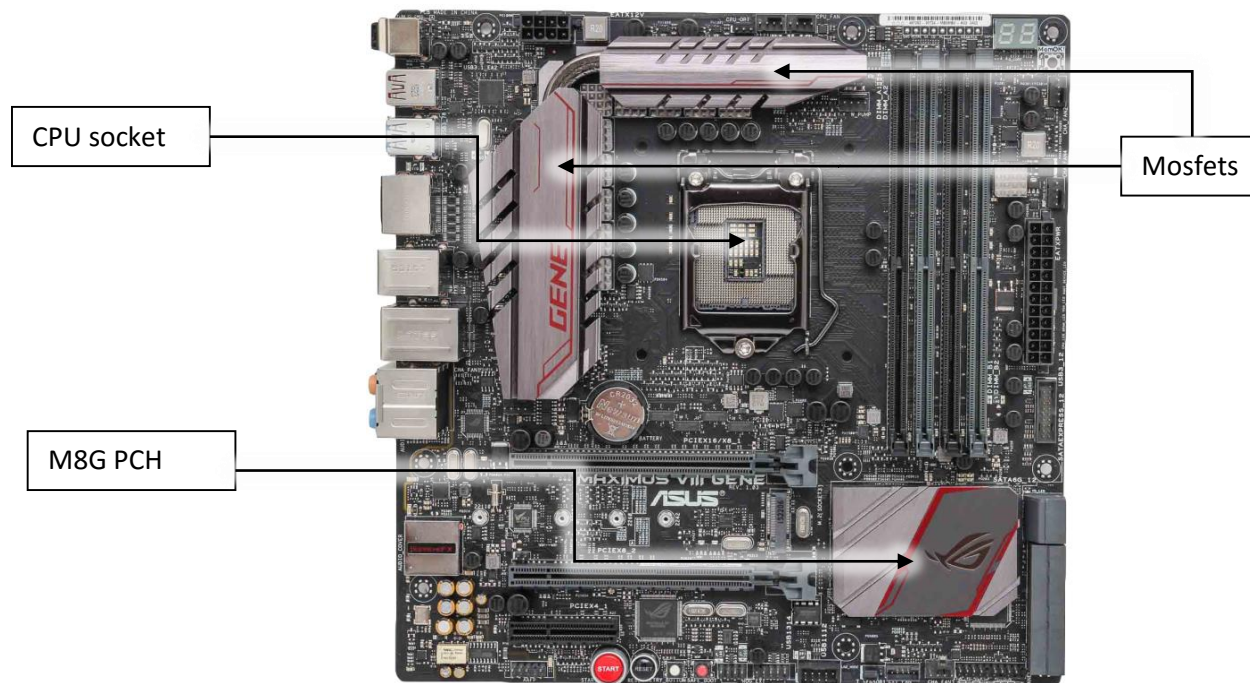

## STEP 1: PREPARING YOUR MOTHERBOARD

**REMOVING STOCK COOLER.** Remove all encircled screws. There are 4 screws on the back of the motherboard that need to be removed in order to remove the factory installed MOSFET heat pipe cooling solution. Please store away the two factory backplates as they will be reused.

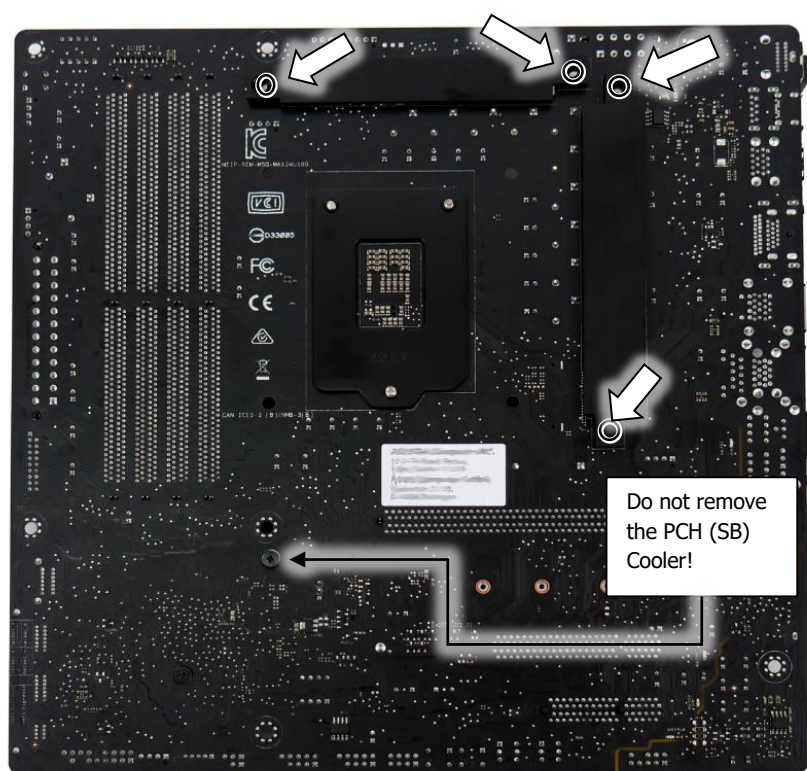

## STEP 2: PREPARING YOUR MOTHERBOARD

**1. APPLYING THERMAL COMPOUND.** Apply thermal compound on CPU heat spreader (IHS) - see sample photo on right with enclosed EK-TIM Ectotherm thermal grease.

The quantity of about two rice grains is just about right. There is no need to cover the whole IHS. Applying too much thermal grease will have negative impact on the cooling performance!



**2.. CUTTING THERMAL PADS.** Your block comes with thermal pads which needs to be trimmed in order to fit the voltage regulation area (MOSFET) on the motherboard's circuit board. **WARNING: DIMENSIONS ON PICTURES BELOW ARE SCALED.**

**Replacement thermal pads @ EKWB web shop:**

- Thermal PAD F 1mm - (120x16mm) [EAN: 3830046996732]
- Thermal PAD F 0,5mm - (120x16mm) [EAN: 3830046996725]
- Thermal PAD F 1,5mm - (120x16mm) [EAN: 3830046996749]

This waterblock is compatible with three motherboard models:

1. ASUS Maximus VIII Hero
2. ASUS Maximus VIII Ranger
3. ASUS Maximus VIII Gene

**These motherboards have different inductor coils therefore you must be careful to install the correct thermal pad.**

At motherboards 2. And 3. You MUST use thermal pad F – **0,5mm**.

At motherboard 1. You must use thermal pad F – **1,5mm**.

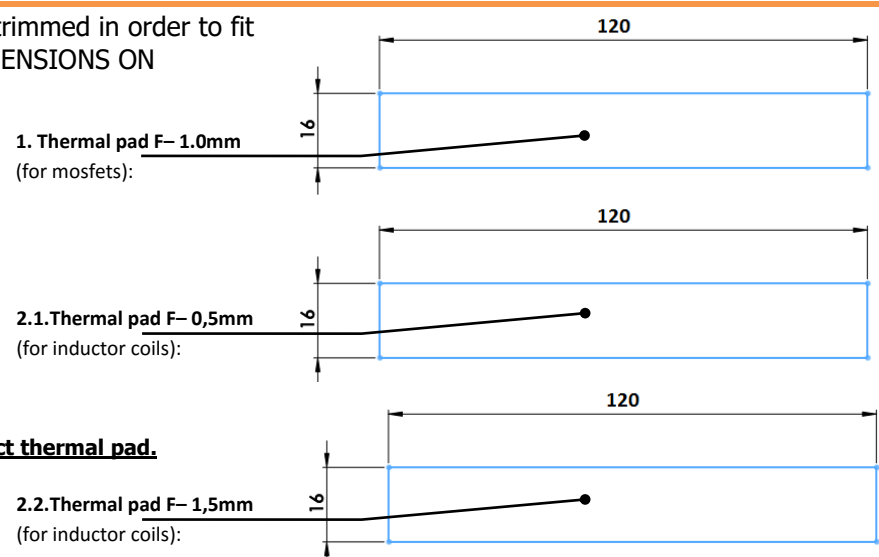

Place 1mm thermal pads in larger strips over marked area and make sure all mosfet chips are covered.

3. PLACING THERMAL PADS ON MOTHERBOARD. Place thermal pads on PCB as shown on the picture

PLEASE REMOVE THE PROTECTIVE FOIL FROM BOTH SIDES OF THE THERMAL PADS PRIOR TO INSTALLATION!

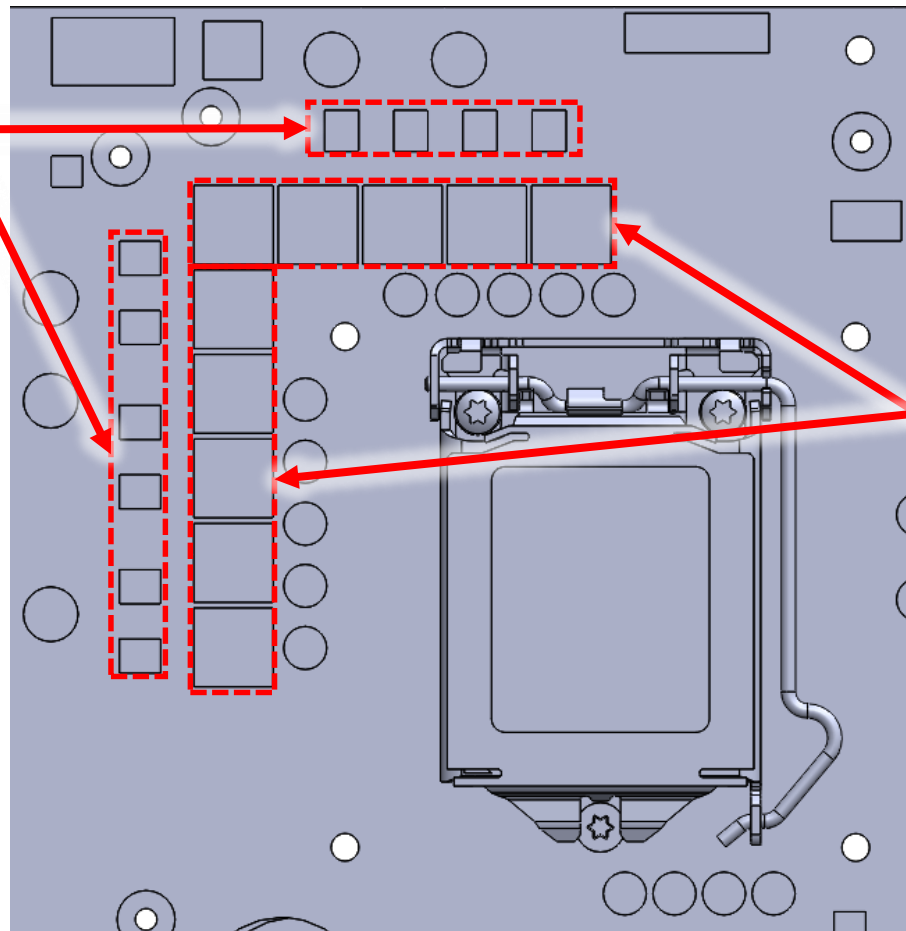

Place 0,5mm (MB M8 Ranger and Gene) or 1,5mm (MB M8 Hero) thermal pads in larger strips over marked area and make sure all Inductor chips are covered.

### STEP 3: PLACING THE BLOCK ON TO MOTHERBOARD

PLACING THE BLOCK ON THE MOTHERBOARD. Place the EK-FB ASUS M8G Monoblock series water block gently to the motherboard or vice versa (as shown on photo below). Make sure that mounting holes are aligned.

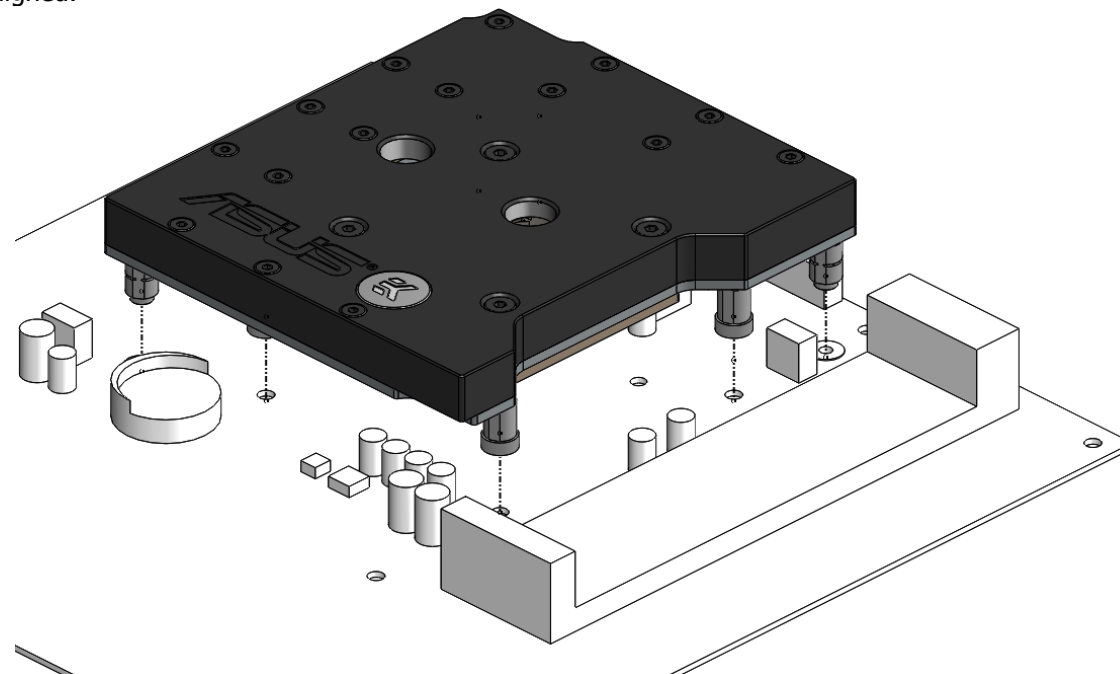

### STEP 4: ATTACHING BLOCK ON TO THE MOTHERBOARD

Prior to fastening the screws please make sure the mounting holes on the motherboard's circuit board are aligned with the water block.

A) **Mosfet part:** Use four M2,5x8 DIN 7985 with factory backplates. Tighten the screws evenly. Do not use excessive force when tightening the screws!

B) **CPU part:** Use four M4x8 DIN7984 with screws and washers. Tighten the screws using enclosed 2.5mm allen key.

**Use the enclosed screws and washers as shown in picture below:**

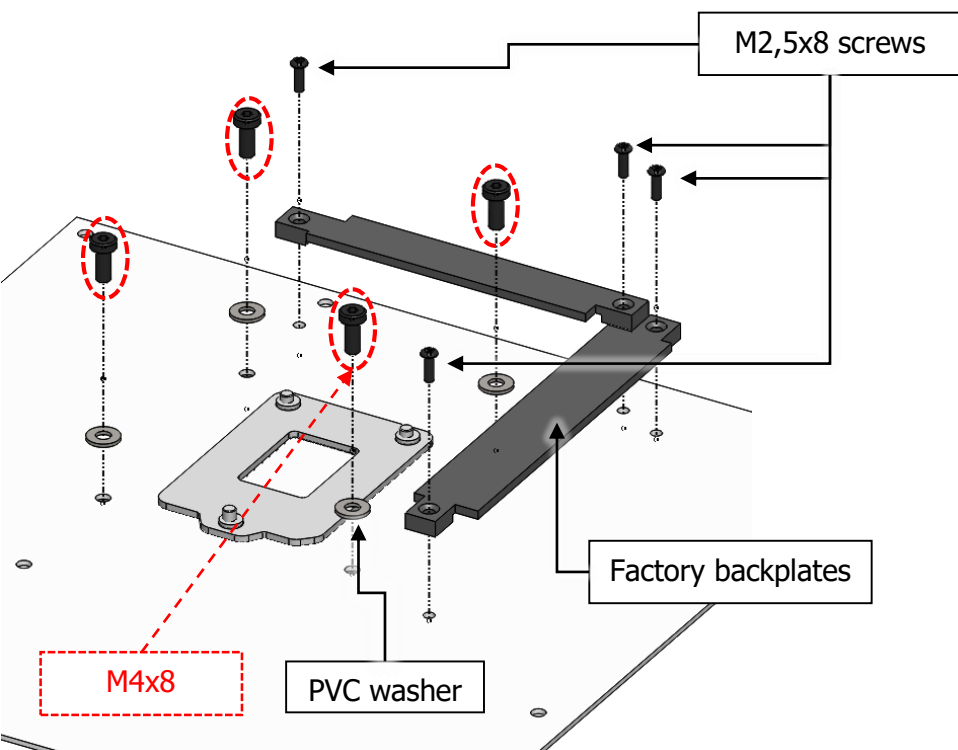

For the EK-FB ASUS M8G Monoblock series water block to operate properly the G1/4 port nearest to the right edge of the water block **MUST BE USED AS THE INLET PORT**. EK recommends the use of EK-ACF fittings. When using fittings other than EK-ACF series please use hose clamps or appropriate substitute to secure the tubing to the barb. The use of biocide containing and corrosion inhibiting coolant is always recommended for any liquid cooling system.

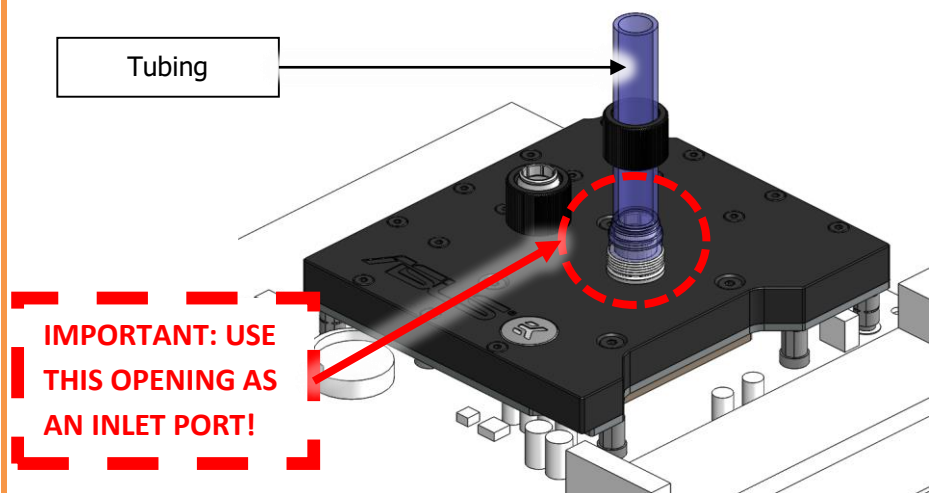

### REQUIRED TOOLS AND MOUNTING SCREWS:

