







EK-FC GeForce GTX FE / EK-FC 1080 GTX Ti

USER GUIDE

GENERAL INFORMATIONS

CONTENT:

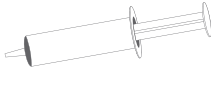
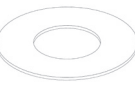
- EK Full Cover Waterblock
- Mounting screws
- Thermal interface material

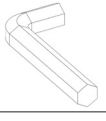
M2,5x4 AX1 16pcs	M2,5x6 AX1 13pcs	M2,5x8 AX1 2pcs	M3x4 DIN7985 2pcs
			
M2,5 helix nut 6pcs	Thermal grease 1pc	PVC washer 16pcs	EK plug G1/4 2pcs
			
			6mm Allen key 1pcs
			

REQUIRED TOOLS:

- Scissors
- Phillips head screwdriver
- 4mm hex socket
- Optional: pliers

/1/

PREPARING YOUR GRAPHICS CARD

Remove all marked screws. For removing of the backplate (if present) use a small Phillips head screwdriver. To remove hex screws from Founders edition graphic card, use 4mm hex socket, optionally you can use pliers. All heat sink assembly screws should be removed, including self-adhesive washers on both sides of the PCB (if present). Also remove the encircled screws on the I/O bracket (if present) using a Phillips head screwdriver.

After you remove the housing, do not forget to unplug the fan.

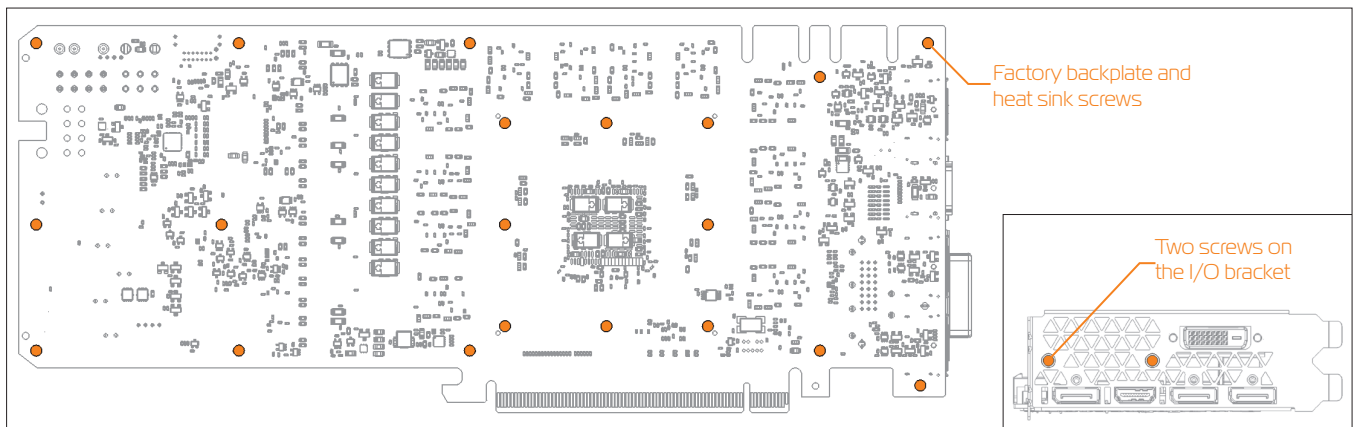
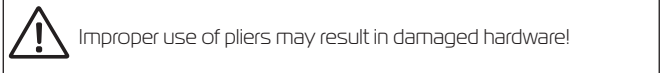

/2/

REPLACING THE ORIGINAL I/O BRACKET (EK-FC 1080 GTX Ti)

Remove 3 (three) Phillips head screws on the factory installed I/O bracket. Replace the original I/O bracket with enclosed EK-FC 1080 GTX Ti I/O bracket and install it using 3 (three) original screws.

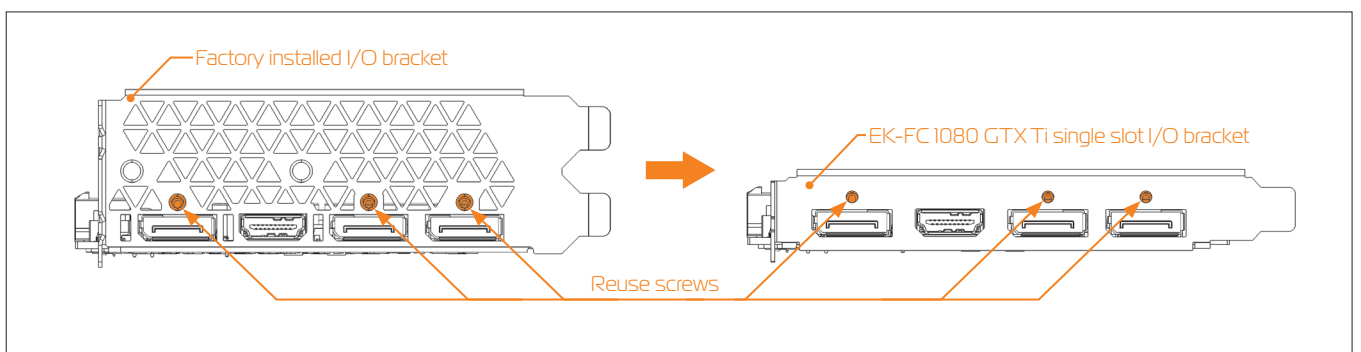

/3/

- 1) Wipe off the remains of the original thermal compound (by using non-abrasive cloth or q-tip) until the components and circuit board are completely clean. EKWB recommends the use of denatured alcohol for removing TIM leftovers.
- 2) Apply enclosed thermal grease on the GPU chip. EKWB recommends to apply thermal grease in cross form for the best performance.
- 3) Your block comes with thermal pads, some of which are already pre-cut. Others have to be cut to smaller chunks in order to cover all the VRM components such as MOSFETs and drivers. PLEASE REMOVE THE PROTECTIVE FOIL FROM BOTH SIDES OF THE THERMAL PADS PRIOR TO INSTALLATION. Place the thermal pads on the circuit board as shown on the picture below. Refer to numbering on left picture when applying thermal pads of different sizes or thicknesses.

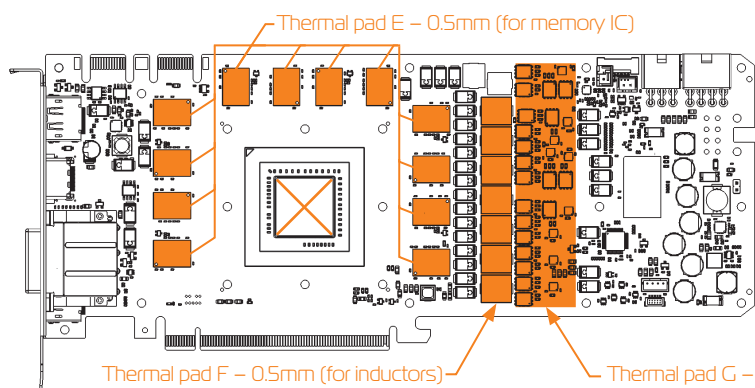

Thermal Pad E – 0.5mm (RAM 8x) – (EAN: 3830046996688)
 Thermal Pad F – 0.5mm (120x16mm) – (EAN: 3830046996725)
 Thermal Pad G – 1.0mm (120x24mm) – (EAN: 3830046996770)

! Remove protective foil from the both sides of the thermal pad prior to installation.

TERMINAL COVER REPLACEMENT (optional)

Remove 2 (two) M4x8 screws using 2,5 Allen key. Remove the terminal cover and replace with alternative one, using 2 (two) M4x8 screws.

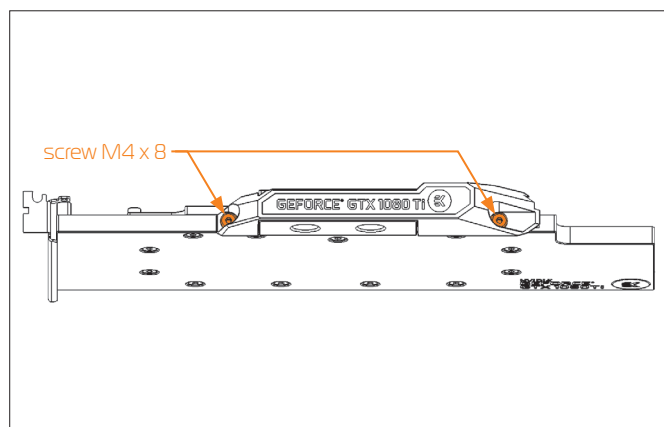

CONNECTING THE TERMINAL COVER LED

CONNECTING THE TERMINAL COVER LED TO THE GRAPHIC CARD. You will find 2-pin header on your graphic card near the power connectors.

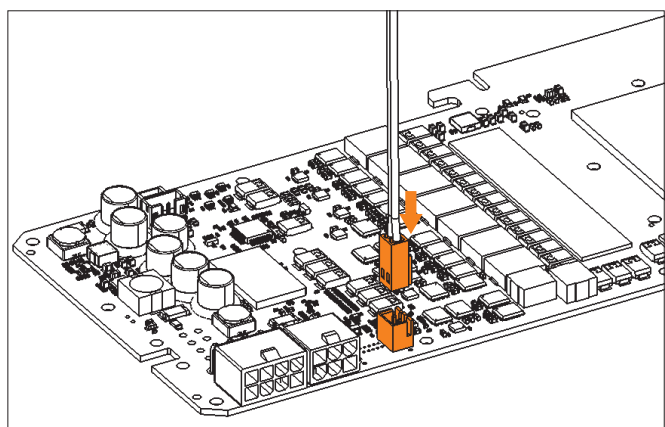

INSTALLING THE WATER BLOCK

1. PLACING THE BLOCK ON TO THE GRAPHICS CARD. Carefully position the water block with preinstalled standoffs on to the graphic card. During this process please make sure you align mounting holes on the PCB with holes on the water block. Also pay attention not to use too much force by pressing the block down to the PCB. Chip dies are prone to cracking.

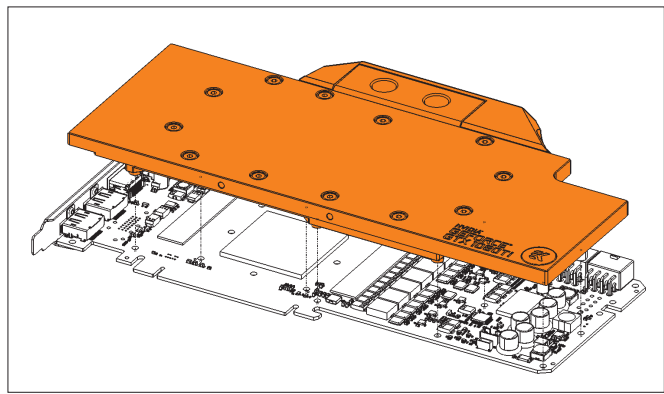

2. SECURING THE BLOCK TO THE GRAPHICS CARD. Use a Phillips screwdriver, screw with the enclosed M2.5x4 AXI screws, 1 (one) M2.5 nut and 2 (two) M2.5x6 AXI screws. EKWB recommends users to start tightening the screws around the GPU core and continue outwards. Always use a plastic washer under each and every screw! If the washer is already present on the circuit board (usually around the four GPU core screw holes) there is no need for additional washer.

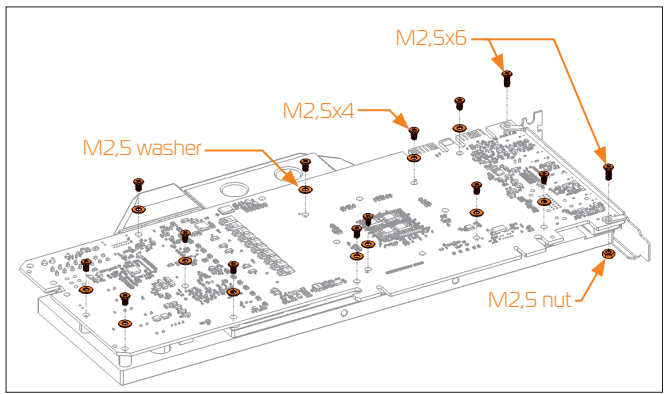

INSTALLING THE FITTINGS AND TUBING

Screw in the two G1/4 threaded male fitting. Attach the liquid cooling tubes and connect the water-block(s) into the cooling circuit. On other two G1/4 openings attach the enclosed plugs.

For best cooling performance use left side of terminal as Inlet and right side as outlet port (look picture below).

