

This product is intended for installation only by expert users. Please consult with a qualified technician for installation. Improper installation may result in damage to your equipment. EK Water Blocks assumes no liability whatsoever, expressed or implied, for the use of these products, nor their installation. The following instructions are subject to change without notice. Please visit our web site at www.ekwb.com for updates. Before installation of this product please read important notice, disclosure and warranty conditions printed on the back of the box.

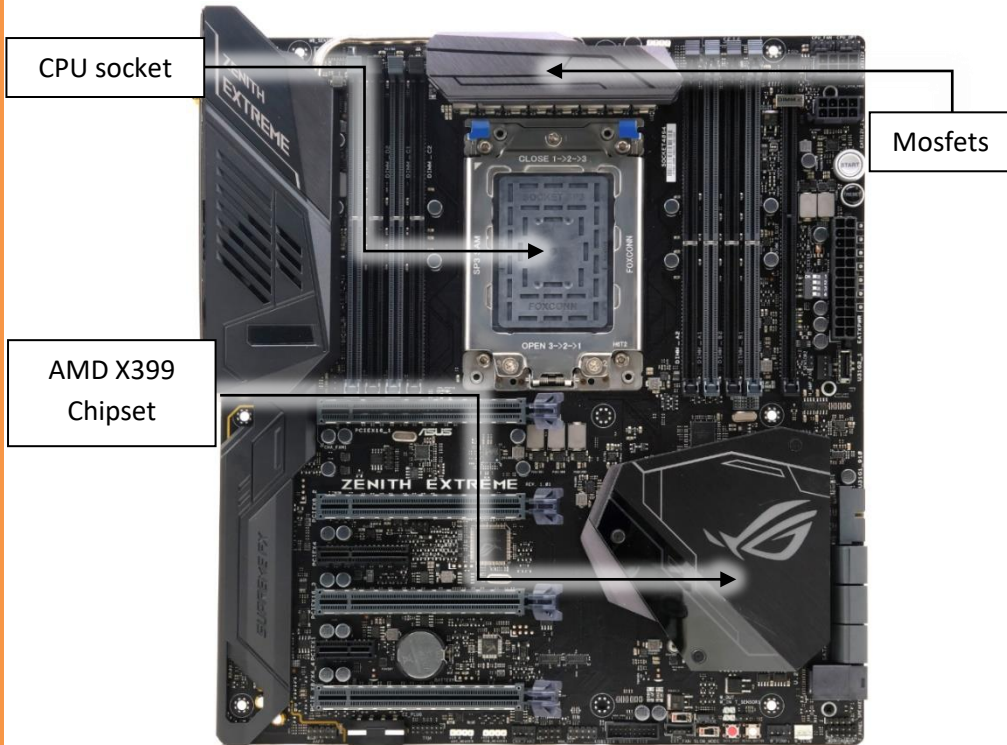





Before you start using this product please follow these basic guidelines:

1. Please carefully read the manual thoroughly before beginning with the installation process!
2. Please remove your motherboard from the computer to assure safest mounting process in order to prevent any possible damages to your CPU and/or motherboard's circuit board (PCB).
3. The EK-HFB and EK-ACF type fittings require only a small amount of force to screw them firmly in place since the liquid seal is ensured by the rubber o-ring gaskets.
4. The use of quality, market proved corrosion inhibiting coolants is always strongly recommended for any liquid cooling system.

STEP 1: GENERAL INFORMATION Sample photo of ASUS ZENITH EXTREME motherboard



BAG CONTENT: Bag content is universal for all water blocks, you may not need all screws.

		
Thermal grease	2,5mm Allen key	M2.5 PVC washer
1pc	1pc	3pcs
		
M2.5 adhesive washer	M2.5x5 AX1	M2.5x7 AX1
3pcs	3pcs	3pcs
Replacement mounting mechanism: (EAN: 3830046994691)		

STEP 2: PREPARING YOUR MOTHERBOARD

REMOVING STOCK COOLER. Remove all encircled screws. There are 4 (four) screws on the back of the motherboard that need to be removed in order to remove the factory installed MOSFET heat pipe cooling solution. And 3 (three) screws for the plastic factory I/O cover. Please store away the factory backplate and I/O cover as it will be reused.

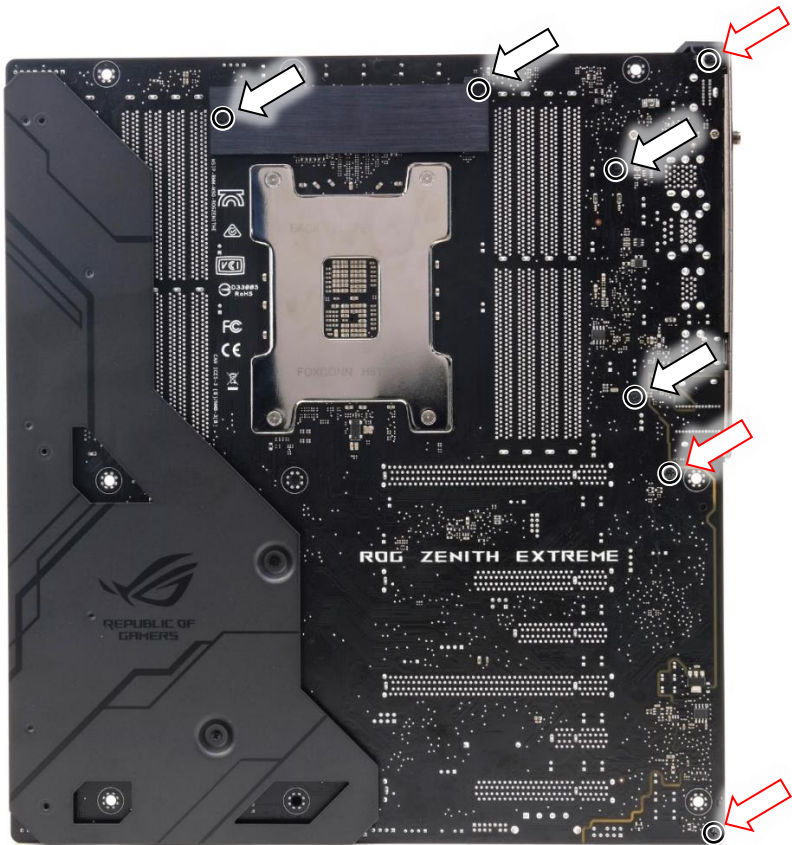

STEP 3: PREPARING YOUR MOTHERBOARD

APPLYING THERMAL COMPOUND. Apply thermal compound on CPU heat spreader (IHS) - see sample photo below with enclosed thermal grease.

The quantity of about two stripes is just about right. There is no need to cover the whole IHS. Applying too much thermal grease will have negative impact on the cooling performance!



STEP 4: CUTTING THERMAL PADS

Your block comes with thermal pads which needs to be trimmed in order to fit the voltage regulation area (MOSFET) on the motherboard's circuit board. **WARNING: DIMENSIONS ON PICTURES BELOW ARE SCALED.**

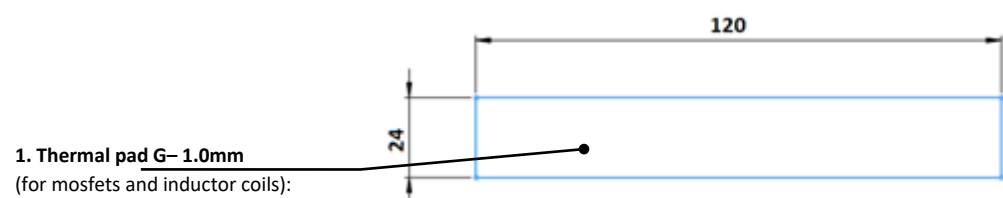

Replacement thermal pads @ EKWB web shop:
Thermal PAD G 1mm - (120x24mm) [EAN: 3830046996770]

STEP 5: PLACING THERMAL PADS

Place thermal pads on PCB as shown on the picture below.

PLEASE REMOVE THE PROTECTIVE FOIL FROM BOTH SIDES OF THE THERMAL PADS PRIOR TO INSTALLATION!

Place 1mm thermal pads in large strip over marked area and make sure all mosfet chips and inductor coils are covered.

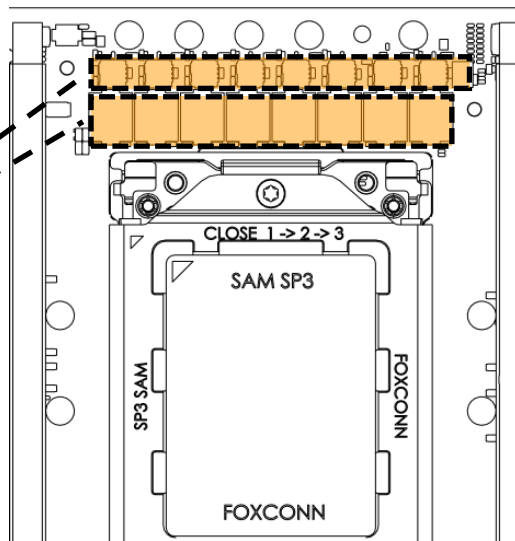

STEP 6: PLACING A BLOCK ON TO THE MOTHERBOARD

Place the EK-FB ASUS ROG ZE Monoblock series water block gently to the motherboard or vice versa (as shown on photo below). Make sure that mounting holes are aligned. Place it on factory installed washers on the motherboard (MOSFET area).

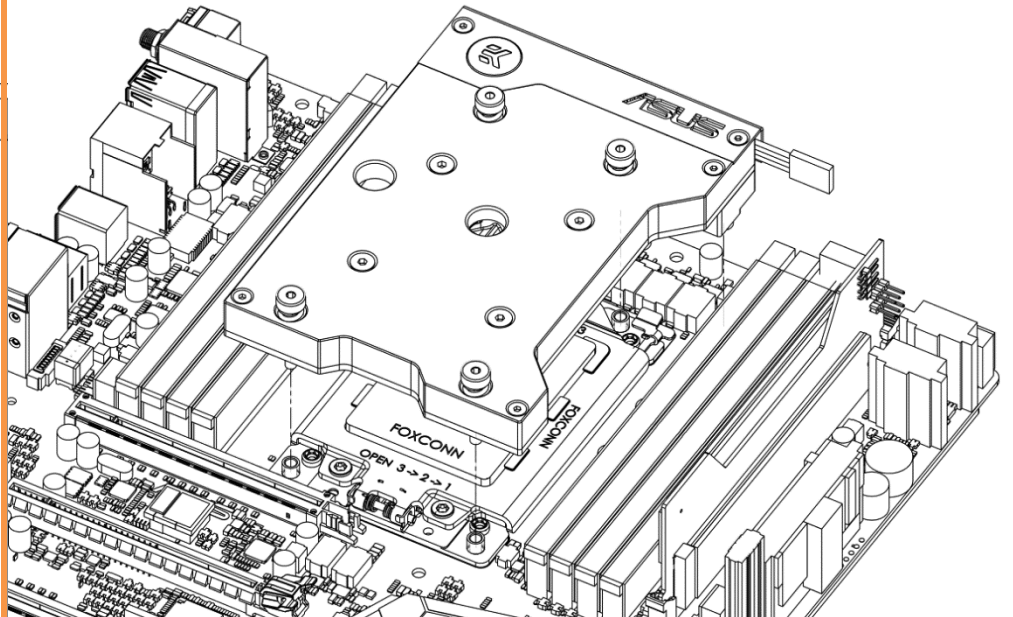

STEP 7.1: ATTACHING A BLOCK ON TO THE MOTHERBOARD

Prior to fastening the screws please make sure the mounting holes on the motherboard's circuit board are aligned with the water block. Secure top 4 (four) nickel screws with enclosed 2,5mm Allen key. Tighten screws diagonally and evenly till the end of the thread. Do not use excessive force when tightening the screws!

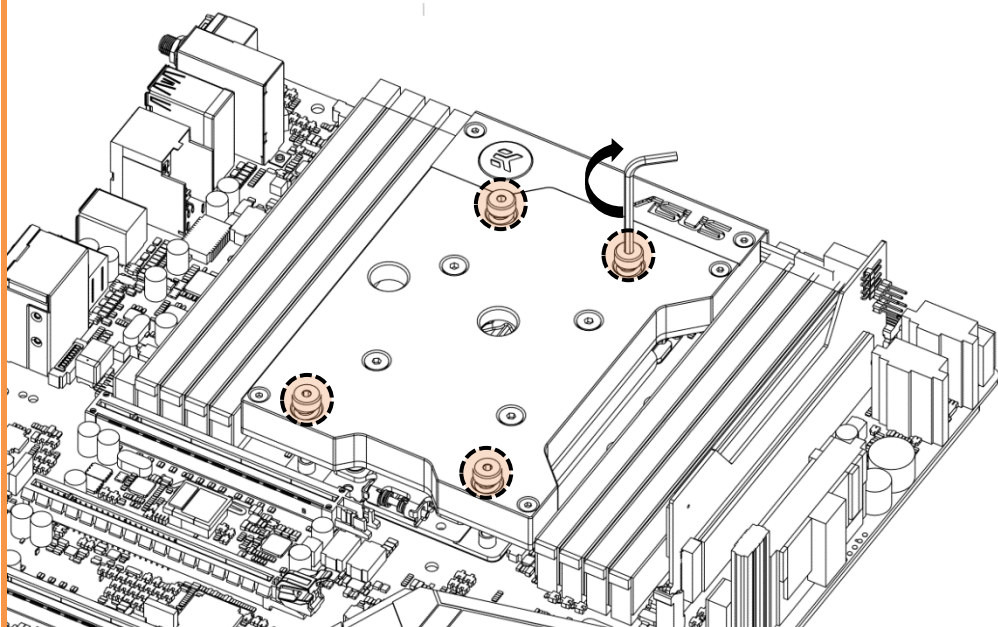

STEP 7.2: ATTACHING A BLOCK ON TO THE MOTHERBOARD

Prior to fastening the screws please make sure the mounting holes on the motherboard's circuit board are aligned with the water block. Use 2 (two) M2,5x7 AX1 screws with original backplate. Tighten the screws evenly. Do not use excessive force when tightening the screws! Now you can reinstall factory plastic I/O cover.

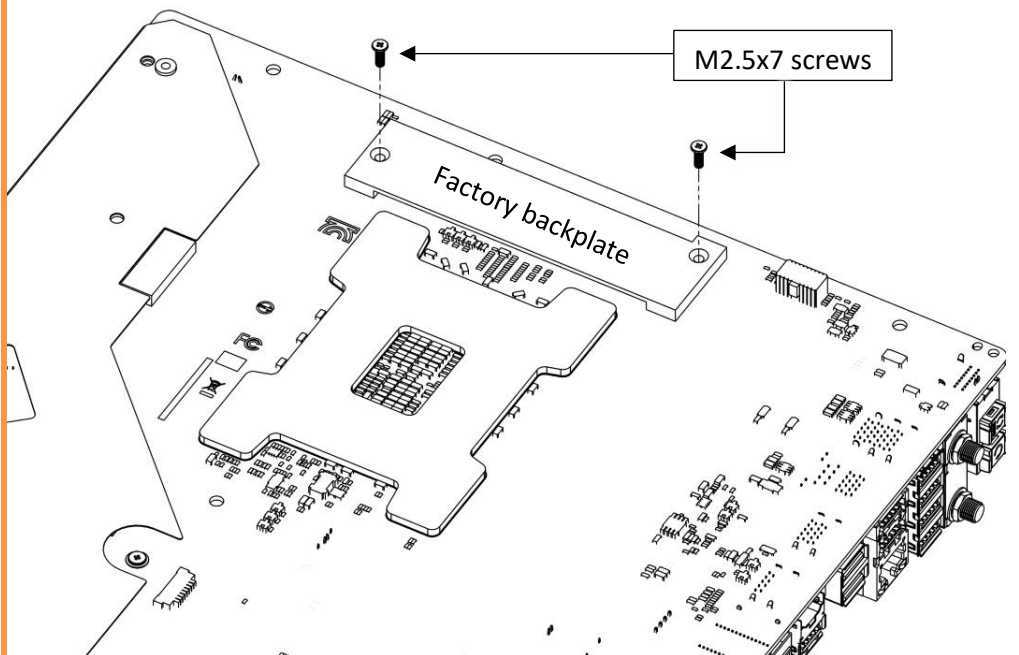

STEP 8: CONNECTING THE D-RGB LED STRIP (optional)

Plug the 4-pin connector from Monoblock D-RGB LED strip to the ADD HEADER on the motherboard. Please ensure that the arrow indicated on the connector is plugged into the +5V line as indicated on your motherboard. Failure to do so will damage your motherboard or LED strip.



For the EK-FB ASUS ROG ZE Monoblock series water block to operate properly the G1/4 port nearest to the right edge of the water block **MUST BE USED AS THE INLET PORT**. EK recommends the use of EK-ACF fittings. When using fittings other than EK-ACF series please use hose clamps or appropriate substitute to secure the tubing to the barb. The use of biocide containing and corrosion inhibiting coolant is always recommended for any liquid cooling system.

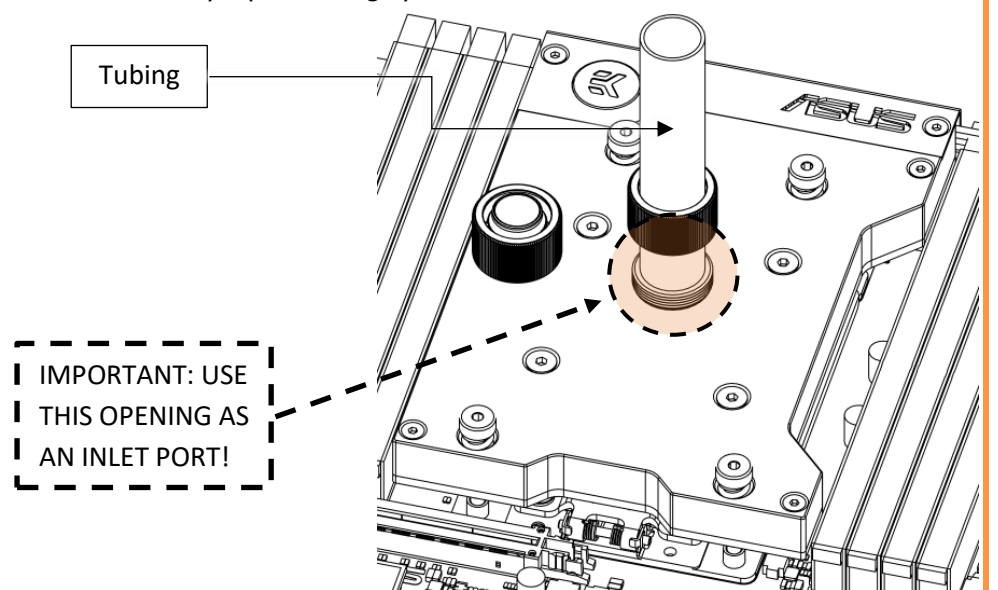

REQUIRED TOOLS AND MOUNTING SCREWS:

