

This product is intended for installation only by expert users. Please consult with a qualified technician for installation. Improper installation may result in damage to your equipment. EK Water Blocks assumes no liability whatsoever, expressed or implied, for the use of these products, nor their installation. The following instructions are subject to change without notice. Please visit our web site at www.ekwb.com for updates. Before installation of this product please read important notice, disclosure and warranty conditions printed on the back of the box.

Before you start using this product please follow these basic guidelines:





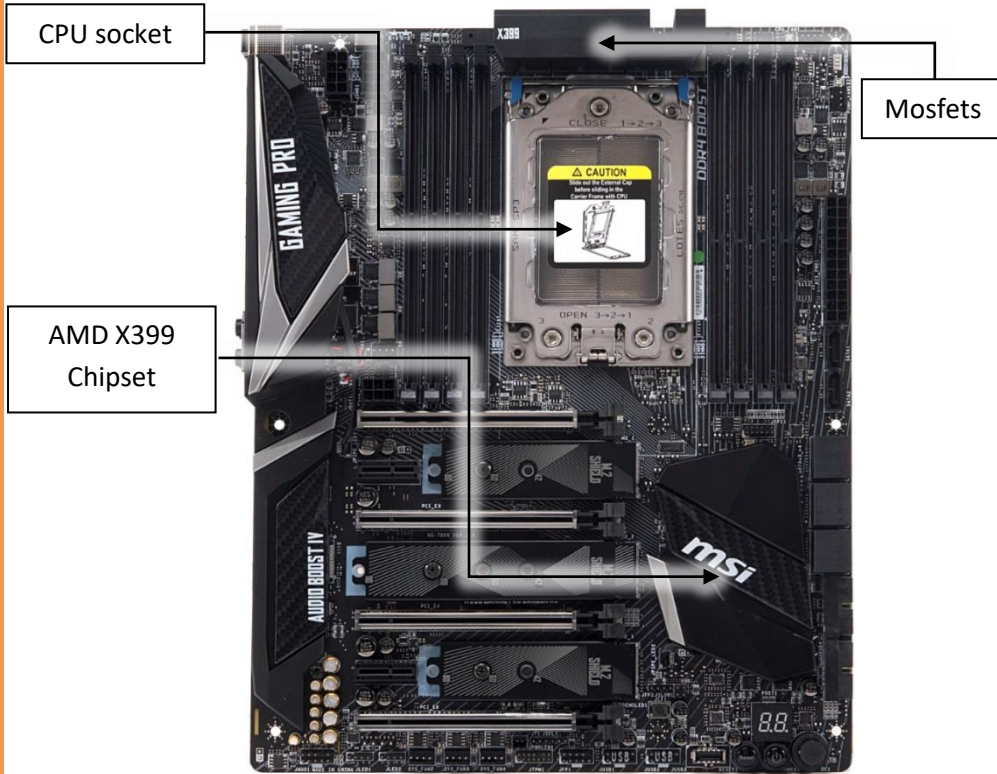

1. Please carefully read the manual thoroughly before beginning with the installation process!
2. Please remove your motherboard from the computer to assure safest mounting process in order to prevent any possible damages to your CPU and/or motherboard's circuit board (PCB).
3. The EK-HFB and EK-ACF type fittings require only a small amount of force to screw them firmly in place since the liquid seal is ensured by the rubber o-ring gaskets.
4. The use of quality, market proved corrosion inhibiting coolants is always strongly recommended for any liquid cooling system.

STEP 1: GENERAL INFORMATION

Sample photo of MSI X399 GAMING PRO CARBON AC motherboard



BAG CONTENT: Bag content is universal for all water blocks, you may not need all screws.

| | | |
|---|---|---|
|  |  |  |
| Thermal grease | 2,5mm Allen key | M2.5 PVC washer |
| 1pc | 1pc | 3pcs |
|  |  |  |
| M2.5 adhesive washer | M2.5x5 AX1 | M2.5x7 AX1 |
| 3pcs | 3pcs | 3pcs |
| Replacement mounting mechanism: (EAN: 3830046994691) | | |

STEP 2: PREPARING YOUR MOTHERBOARD

REMOVING STOCK COOLER. Remove all encircled screws. There are 2 (two) screws on the back of the motherboard that need to be removed in order to remove the factory installed MOSFET cooling solution.

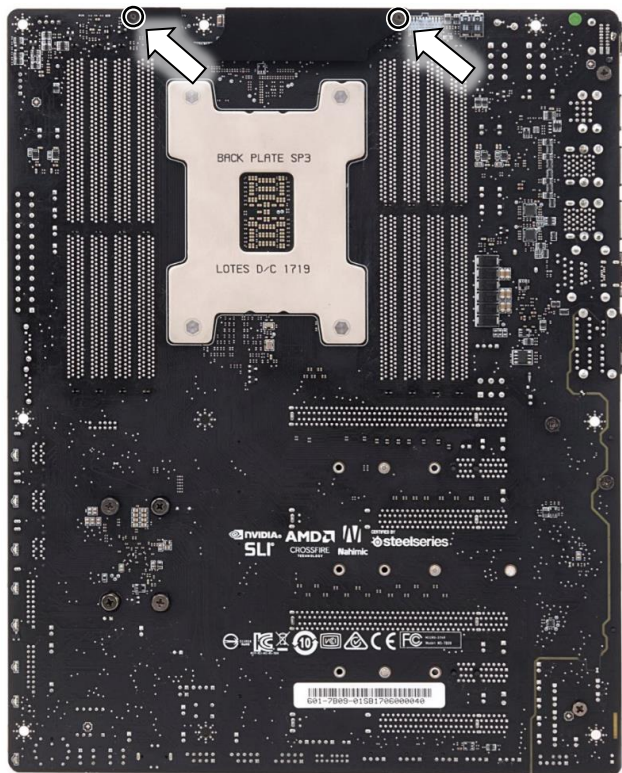

STEP 3: PREPARING YOUR MOTHERBOARD

APPLYING THERMAL COMPOUND. Apply thermal compound on CPU heat spreader (IHS) - see sample photo below with enclosed thermal grease.

The quantity of about two stripes is just about right. There is no need to cover the whole IHS. Applying too much thermal grease will have negative impact on the cooling performance!



STEP 4: CUTTING THERMAL PADS

Your block comes with thermal pads which needs to be trimmed in order to fit the voltage regulation area (MOSFET) on the motherboard's circuit board. **WARNING: DIMENSIONS ON PICTURES BELOW ARE SCALED.**

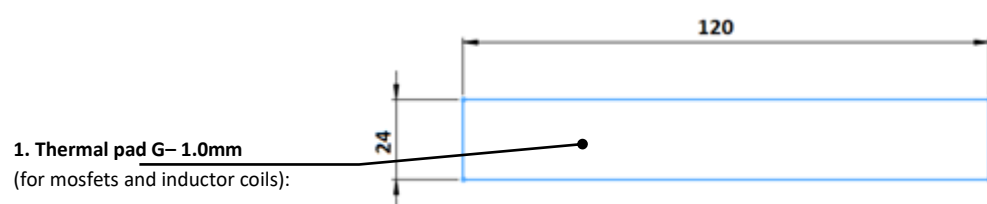

Replacement thermal pads @ EKWB web shop:
Thermal PAD G 1mm - (120x24mm) [EAN: 3830046996770]

STEP 5: PREPARING THE MONOBLOCK

Place the M2,5 self-adhesive PVC washers under marked standoffs!

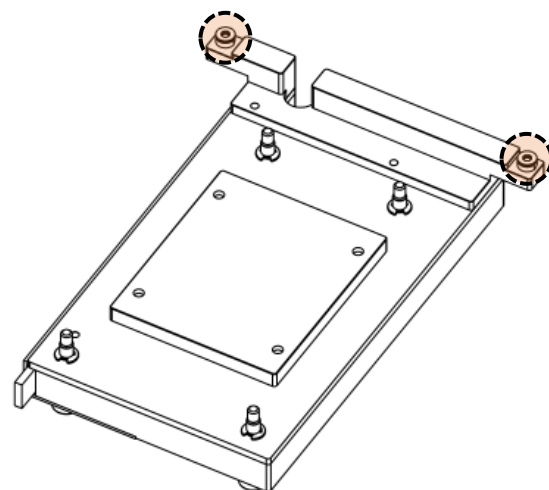

STEP 6: PLACING THERMAL PADS

Place thermal pads on PCB as shown on the picture below.

PLEASE REMOVE THE PROTECTIVE FOIL FROM BOTH SIDES OF THE THERMAL PADS PRIOR TO INSTALLATION!

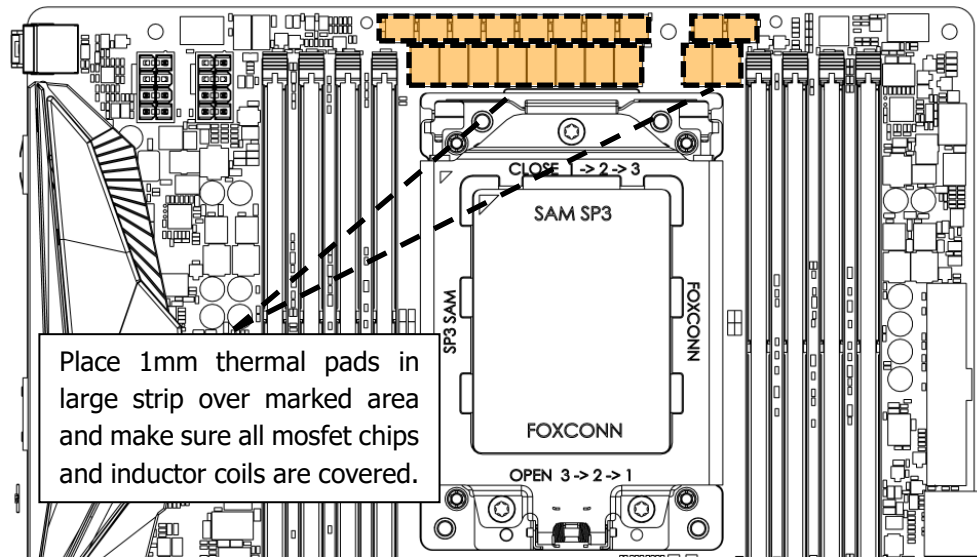

STEP 7: PLACING A BLOCK ON TO THE MOTHERBOARD

Place the EK-FB MSI X399 RGB Monoblock gently to the motherboard or vice versa (as shown on photo below). Make sure that mounting holes are aligned.

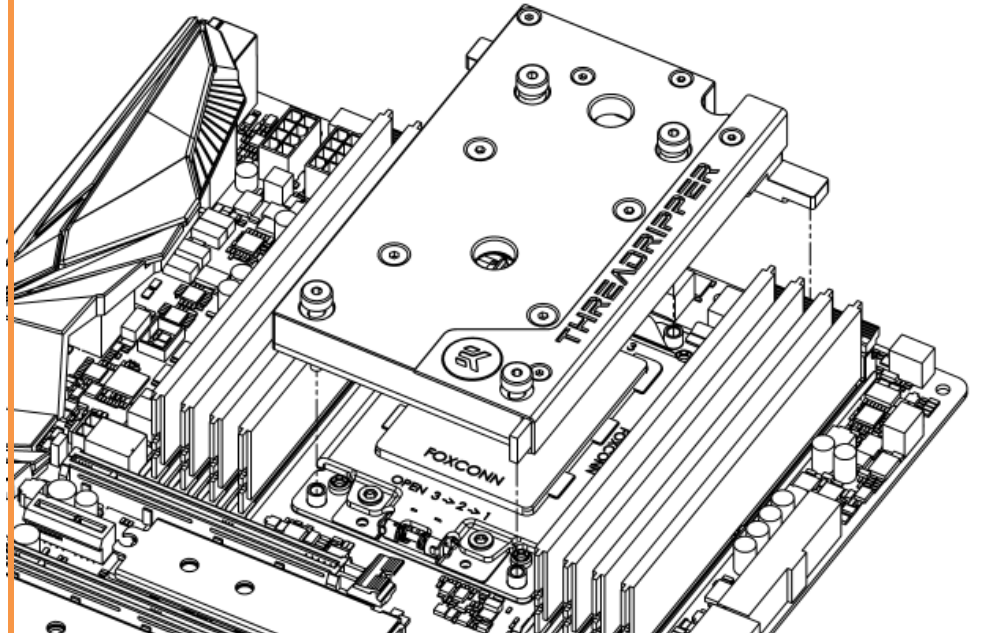

STEP 8.1: ATTACHING A BLOCK ON TO THE MOTHERBOARD

Prior to fastening the screws please make sure the mounting holes on the motherboard's circuit board are aligned with the water block. Secure top 4 (four) nickel screws with enclosed 2,5mm Allen key. Tighten screws diagonally and evenly till the end of the thread. Do not use excessive force when tightening the screws!

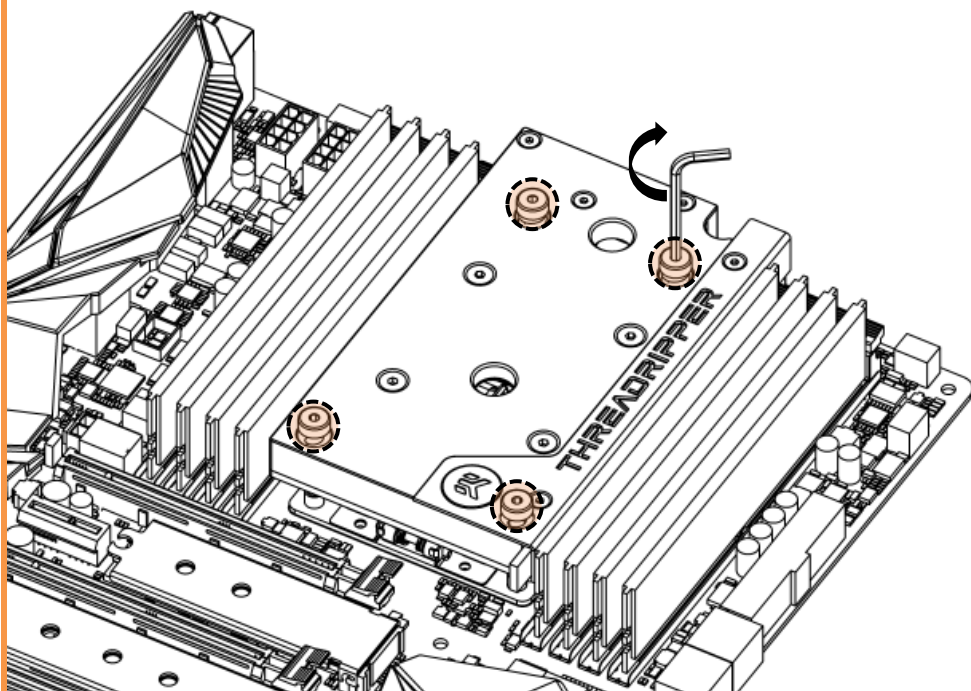

STEP 8.2: ATTACHING A BLOCK ON TO THE MOTHERBOARD

Prior to fastening the screws please make sure the mounting holes on the motherboard's circuit board are aligned with the water block. Use 2 (two) M2,5x5 AX1 screws with M2.5 PVC washers. Tighten the screws evenly. Do not use excessive force when tightening the screws!

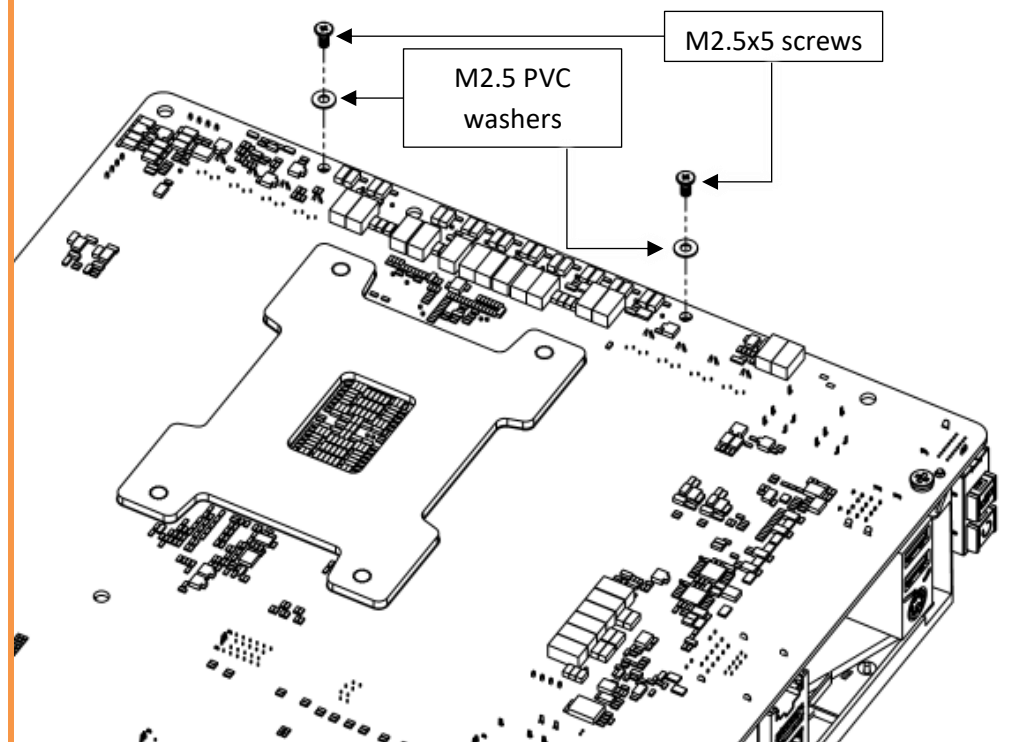

STEP 9: CONNECTING THE RGB LED STRIP (optional)

Plug the 4-pin connector from Monoblock RGB LED strip to the JLED1 header on your motherboard. Please ensure that the arrow indicated on the connector is plugged into the 12v line as indicated on your motherboard. Failure to do so will damage your motherboard or LED strip.

For the EK-FB MSI X399 RGB Monoblock series water block to operate properly the lower G1/4 port of the water block **MUST BE USED AS THE INLET PORT**. EK recommends the use of EK-ACF fittings. When using fittings other than EK-ACF series please use hose clamps or appropriate substitute to secure the tubing to the barb. The use of biocide containing and corrosion inhibiting coolant is always recommended for any liquid cooling system.

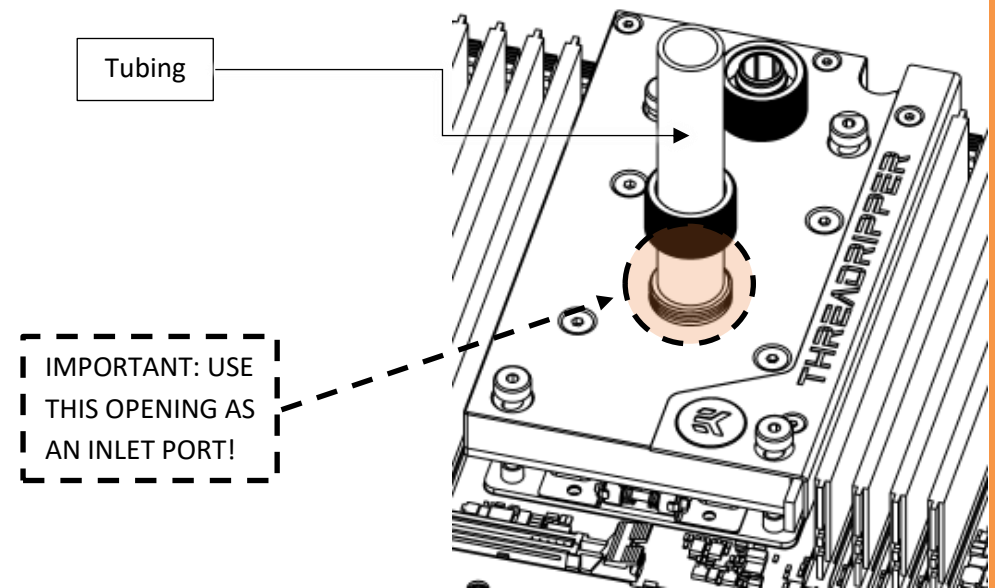
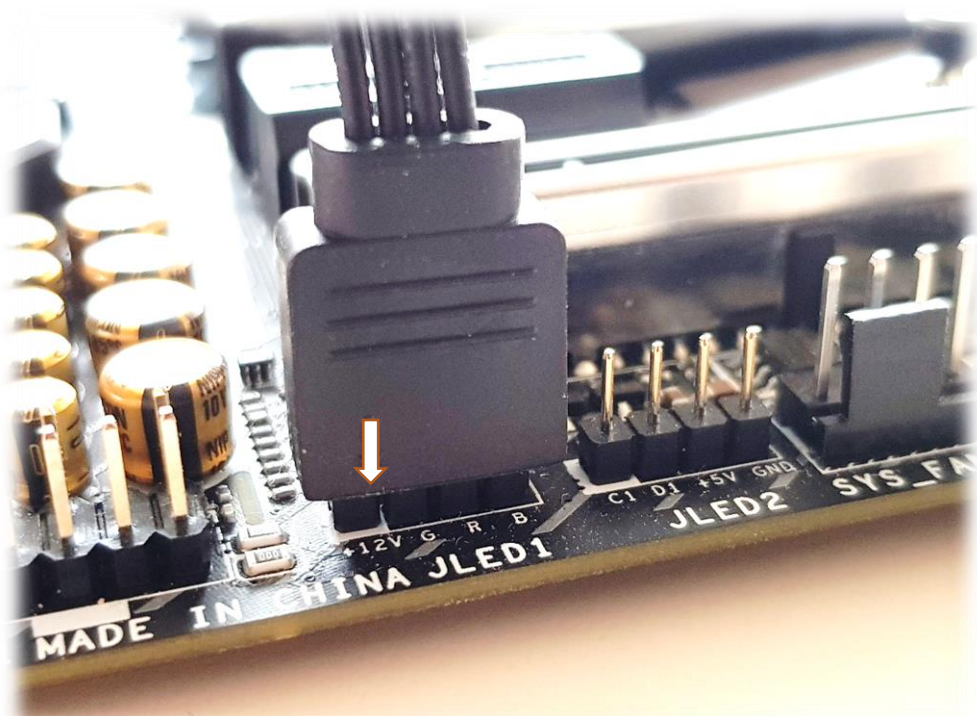

REQUIRED TOOLS AND MOUNTING SCREWS:

